

FEATURES

Full-Featured Evaluation Board for the
AD73360 & AD73360L
Stand Alone Operation
On-Board DSP
High-Speed Parallel Interface to the PC
PC Software for Control and Data Analysis.

INTRODUCTION

This Technical Note describes the evaluation board for the both AD73360 and the AD73360L six input-channel simultaneous sampling sigma-delta A/D converters. The AD73360L is a 3V only version of the AD73360. Full data on the both parts is available in the relevant data sheet available from Analog Devices and should be consulted in conjunction with this Technical Note when using the Evaluation Board.

The evaluation board allows a user to exercise all the functions of the AD73360(L). The analog inputs are buffered by op-amps which may be configured for ac- or dc-coupling operation. The evaluation board contains an ADSP2185L digital signal processor which can be programmed to control and read data from the AD73360(L). The evaluation board comes with software which can be run on the users PC allowing programs to be downloaded and data to be uploaded from the evaluation board. Several example programs are provided which demonstrate the capabilities of the AD73360(L).

SETTING UP THE EVALUATION BOARD FOR THE FIRST TIME

The AD73360(L) evaluation board kit comes with the evaluation board for the required part, AD73360 or AD73360L and software which allows the user to program the AD73360(L) and read back samples using a PC. The software is provide on a CD ROM and this also contains a data sheet, this technical note and some DSP example code. The user needs to supply a Centronics printer port cable and a 6V to 12V DC power supply.

Installing the Software

When the CD ROM is inserted into the PCs drive the install routine automatically starts. This allows the user to select which components to install i.e. data sheet, technical note, application software etc. When using the software to control the evaluation board it is important the following steps are completed in order.

1. The evaluation board should be powered up with the printer port cable disconnected.
2. The software should be loaded.
3. The printer port cable can then be connected and the PC should be able to communicate with the evaluation board.

FUNCTIONAL BLOCK DIAGRAM

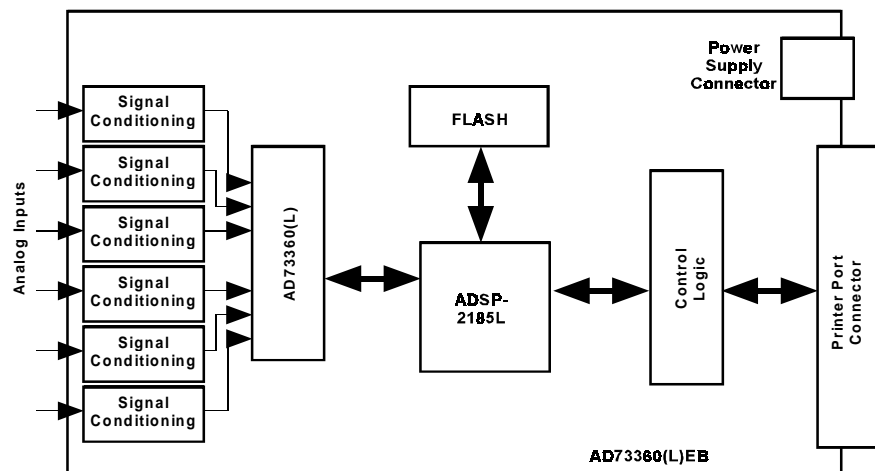

REV. 0

Information furnished by Analog Devices is believed to be accurate and reliable. However, no responsibility is assumed by Analog Devices for its use, nor for any infringements of patents or other rights of third parties which may result from its use. No license is granted by implication or otherwise under any patent or patent rights of Analog Devices.

EVAL-AD73360(L)EB

System Requirements

Pentium 90 IBM Compatible PC

Windows 95

4Mbytes Hard Disk Space

Bidirectional Printer Port (PS/2, EPP, ECP)

OPERATING THE AD73360(L) EVALUATION BOARD

Power Supply

The AD73360(L) evaluation board can be powered from any +9 V to +12 V DC power supply connected to J10 on the board. This supply is regulated to +5 V to power the PC interface section of the board and also regulated to +3.2 V to power the DSP and AD73360(L) sections. The analog section of the AD73360 can also be powered from +5 V if required. This should only be done when the AD73360 is used in the evaluation board.

When power is applied the POWER LED D4 should be lit indicating that the power connector is correctly polarized. Also the LED connected to FL2 should begin to flash on and off indicating that the DSP has booted from the on-board flash EPROM correctly.

When the evaluation board has been powered up the PC software can be loaded and the printer port connector can be connected. the PC should now be able to communicate with the evaluation board.

Link Settings

The AD73360(L) evaluation board has a number of link options which can be used to select the various operating conditions of the evaluation board. The linking options are described in detail below.

Table I. Interface Mode Selection

Link	Position	Function
LK1	A ¹	Frame-Sync Loop Back
	B	Non Frame-Sync Loop Back

¹ Default Link Position

Table II. Crystal Frequency Selection

LK2	LK3	LK4	Fout
IN	IN	IN	Fo/2 ^{1 2}
IN	IN	OUT	Fo/4
IN	OUT	IN	Fo/8
IN	OUT	OUT	Fo/16
OUT	IN	IN	Fo/32
OUT	IN	OUT	Fo/64
OUT	OUT	IN	Fo/128
OUT	OUT	OUT	Fo/256

¹ Fo=16.384MHz

² Default Link Positions

Table III. Master Clock Selection

Link	Position	MCLK Frequency
LK5	A ¹	16.384MHz
	B	Fout

¹ Default Link Position

Table IV. Reference Selection

Link	Position	Function
LK6	IN ¹	External Reference
	OUT	Internal Reference

¹ Default Link Position

Table V. Voltage Selection for AD73360(L)

Link	Position	Function
LK7	A	+5V Analog Section
	B ¹	+3V Analog Section

¹ Default Link PositionEvaluation Board Software

EVALUATION BOARD SOFTWARE

The evaluation board comes with software which will allow the user to operate the various functions of the AD73360(L). There are two main sections to the complete software package. One runs on the PC and handles all the communications between the PC and the evaluation board. The PC software can be used to load a DSP based program to the evaluation board which is specifically written to operate the AD73360 in a required manner. The second section of the software is the DSP programs. These are loaded to the ADSP2185L on the evaluation board. The programs are designed to allow the user to gather data from the AD73360 and upload it from to the PC to be saved or analysed. The DSP example programs can be modified and recompiled to meet the needs of the users end application if necessary.

PC Software Description

When the user runs the software they are presented with a selection screen where the user can determine if they want to use the Basic or Demonstration Mode options. The Selection Screen is shown in Figure 1.



Figure 1. Selection Screen

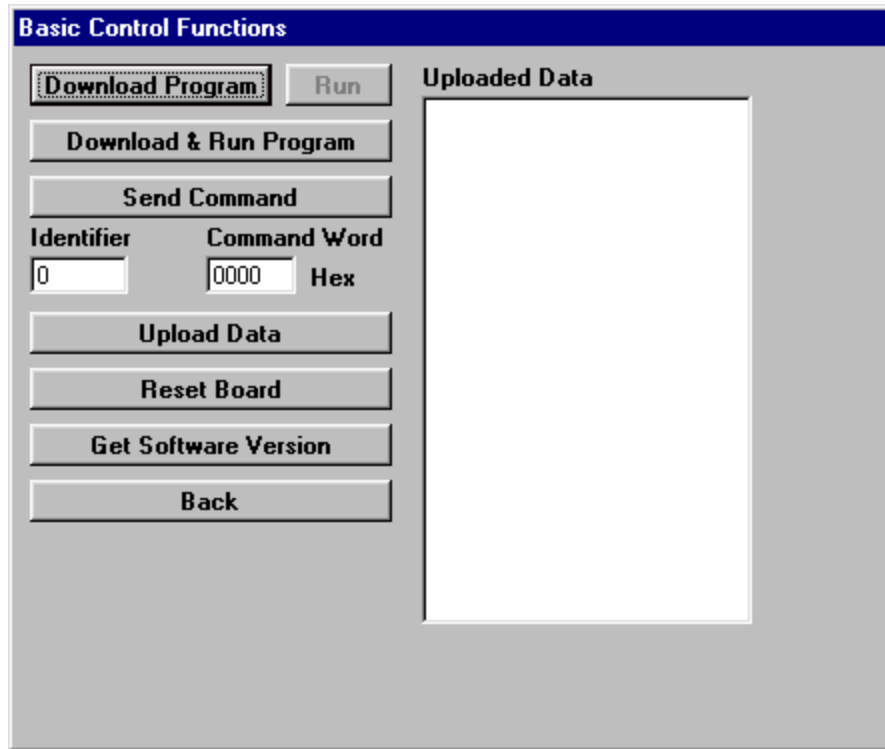

Figure 2. The Basic Mode Screen

When running the software for the very first time it is advisable to select the Basic screen as this will allow the user to verify that the PC is communicating with the evaluation board and vice versa. The Basic Screen is shown in Figure 2. The user should click on the Get Software Version button to establish if the communications are working. If they are the user should see a message box similar to that of Figure 3.

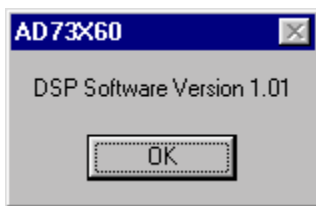

Figure 3. Software Version Message Box

The additional functions available in this screen will be described later in this document.

DEMONSTRATIONS SCREEN

The Demonstrations Screen will allow the user to select one of a number of demonstration programs which will program the AD7360(L) and read data from one or more selected channels. Figure 4 shows the Demonstrations Screen.

Menu Item Descriptions

File Menu:

Save Data: The user can save the ADC samples taken by the AD73360(L). The samples are saved to a text file which can be opened by programs such as Notepad, Excel or Mathcad for further examination/analysis.

Save FFT Data: The user can save the results of the FFTs performed on the ADC data. The data is saved to a text file which can be opened by programs such as Notepad, Excel or Mathcad for further examination/analysis.

Load Data: The user can reload previously saved data into the program. The program will display the ADC samples and recalculate the FFT for each channel.

Options Menu:

Run On Download: Selecting this option will automatically run any program which is downloaded to the DSP. If this option is deselected the Run button must be pressed in order to start the DSP program.

AD73x60 Options: This option allows the user to select the Sample Rate used by the DSP program, the number of ADC samples to be taken by each channel and the Frequency Band of Interest over which to calculate the SNR for each channel.

AD73x60 Options: Selecting this option causes the evaluation board to be reset.

Printer Port: This option allows the user to select which printer port the software should use to communicate with the evaluation board. By default LPT1 is chosen.

EVAL-AD73360(L)EB

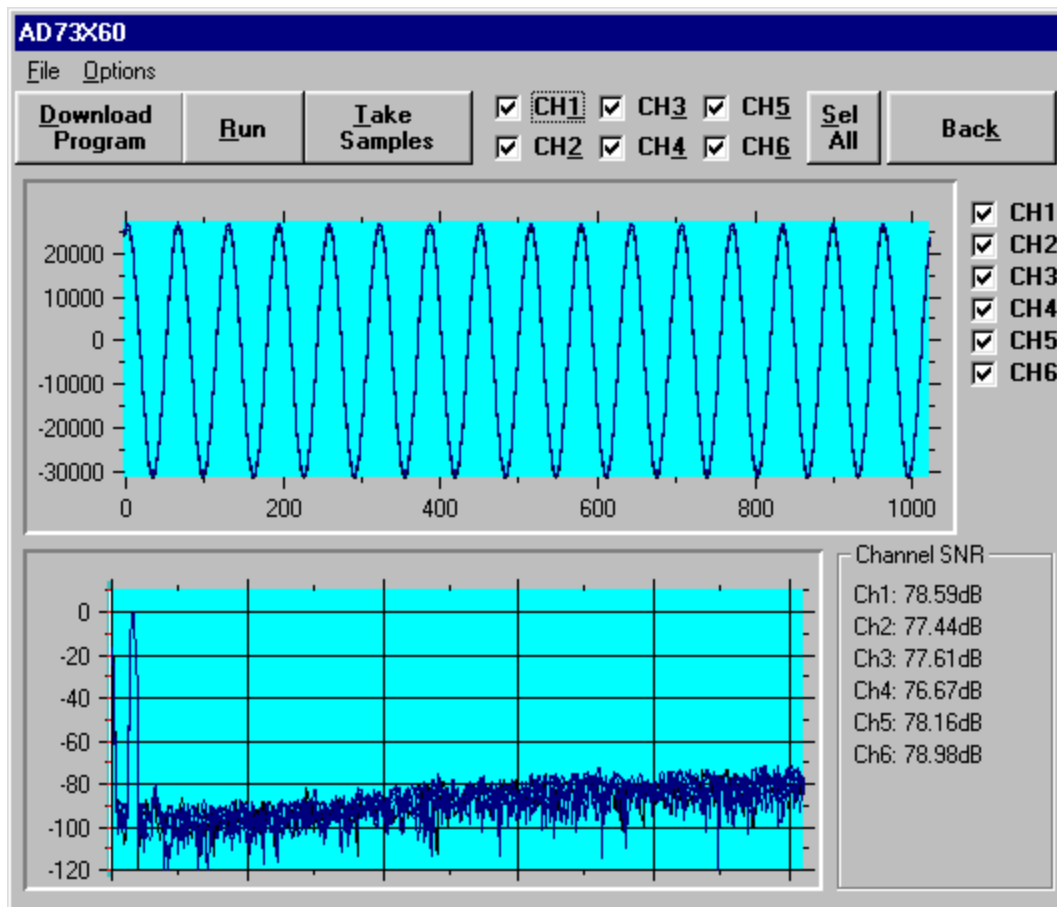

Figure 4. The Demonstration Screen

Demonstration Programs

The demonstration programs provided with the AD73360(L) evaluation board allow the user to program the device and read data from one or more channels. The samples are automatically uploaded and graphed once they have been acquired. In addition a Fast Fourier Transform (FFT) is performed and the Signal to Noise+Distortion Ratio (SNR+D) is calculated for all selected channels. The demonstration programs sample data at either 8KHz or 64KHz. The DSP source code for each demonstration program is included and can be modified and recompiled if required¹.

Running a Demonstration Program

With the evaluation board powered up and connected to the PC the user can download the required program to the evaluation board by pressing the **Download Program** button. This will display a dialog box from which the user can select the required program. When the OPEN button is clicked the evaluation board is reset and the program is downloaded. If the **Run on Download** option is not selected the user must click the **Run** button to start the program running. The user should ensure that the correct sample rate is selected by clicking on the **Options/AD73x60 Options** menu item. The user also has the option to alter the band of interest over which the SNR+D is calculated

and change the number of samples to take. Note that the number of samples which can be taken is limited to the amount of data memory available in the DSP and the number of ADC channels selected. The number of samples selected should not exceed $16000/N$ where N is the number of ADC channels. Figure 5 shows the AD73x60 options window.

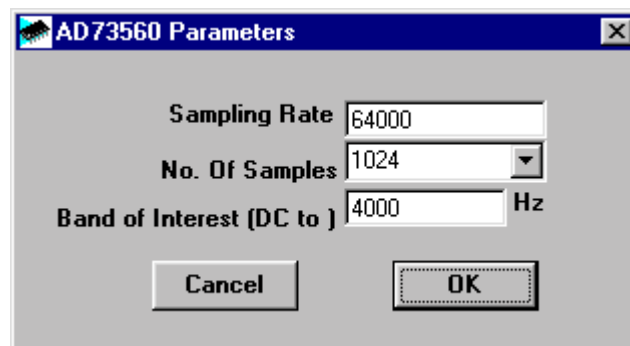

Figure 5. The AD73x60 Options Window

¹ Recompiling DSP source code requires the ADSP21xx assembler and linker tools.

When the DSP program is running the user can click Take Samples. This will cause the the PC to send a command to the DSP on the evaluation board. The DSP will bring the SE and RESET lines of the AD73360(L) high and begin programming the device. The AD73360(L) is configured in Frame-Sync Loop Back and is programmed to operate in Data Mode. After allowing some time for the reference to settle the AD73360(L) will store the required number of samples to the data memory of the DSP. Once completed the DSP will bring the RESET and SE of the AD73360(L) low and begin uploading the data to the PC. When the data has been transferred the PC will graph the data and calculate the FFT. It should be noted that the number of channels selected at the top of the demonstration window should match the number of ADC channels powered up on the AD73360(L).

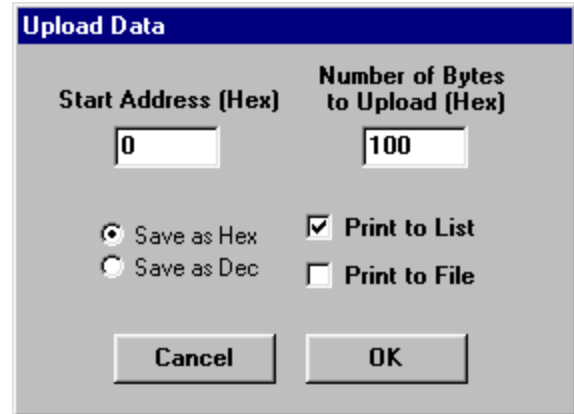

Figure 6. the Upload Data Screen

THE BASIC MODE SCREEN

The Basic Mode Screen as shown in Figure 2 allows the user to download their own programs to the evaluation board, send it commands and upload data memory for saving or analysis.

Downloading Programs

The user has the option of downloading a program to the evaluation board in one of two ways. The first is to download the program but not to run it until the **Run** button is clicked. The second is to download and automatically run the program. If the user is using a modified version of the BASIC.DSP program the LED on FL2 will flash a number of times to indicated that the program has been downloaded and run successfully.

Sending Commands

A command can be sent to the evaluation board which can be used to determine which action is to be performed. The command is made up of an Identifier Byte and a 16 bit Control Word. The Identifier Byte is stored in data memory location 0x3FDB and the Control Word is stored in data memory location 0x3FDA. The BASIC.DSP program will read the Identifier Byte and flash the LED that number of times.

Uploading Data

If the user has acquired ADC data from the AD73360(L) which is stored in data memory it can be uploaded to the PC. Clicking the **Upload Data** button will display the screen shown in Figure 6. The user can select the start address and the number of words to upload. The uploaded data can be saved to a file or to a list box on the Basic Mode Screen. The user also has the option to save/display the data in decimal or hexadecimal format.

Reset Board

This button allows the user to reset the evaluation board if required.

Get Software Version

This button will read the version number of the boot program which is store on the evaluation board. This is a useful indication that the communication routines are fully working as it involves 2-way communication to be successful.

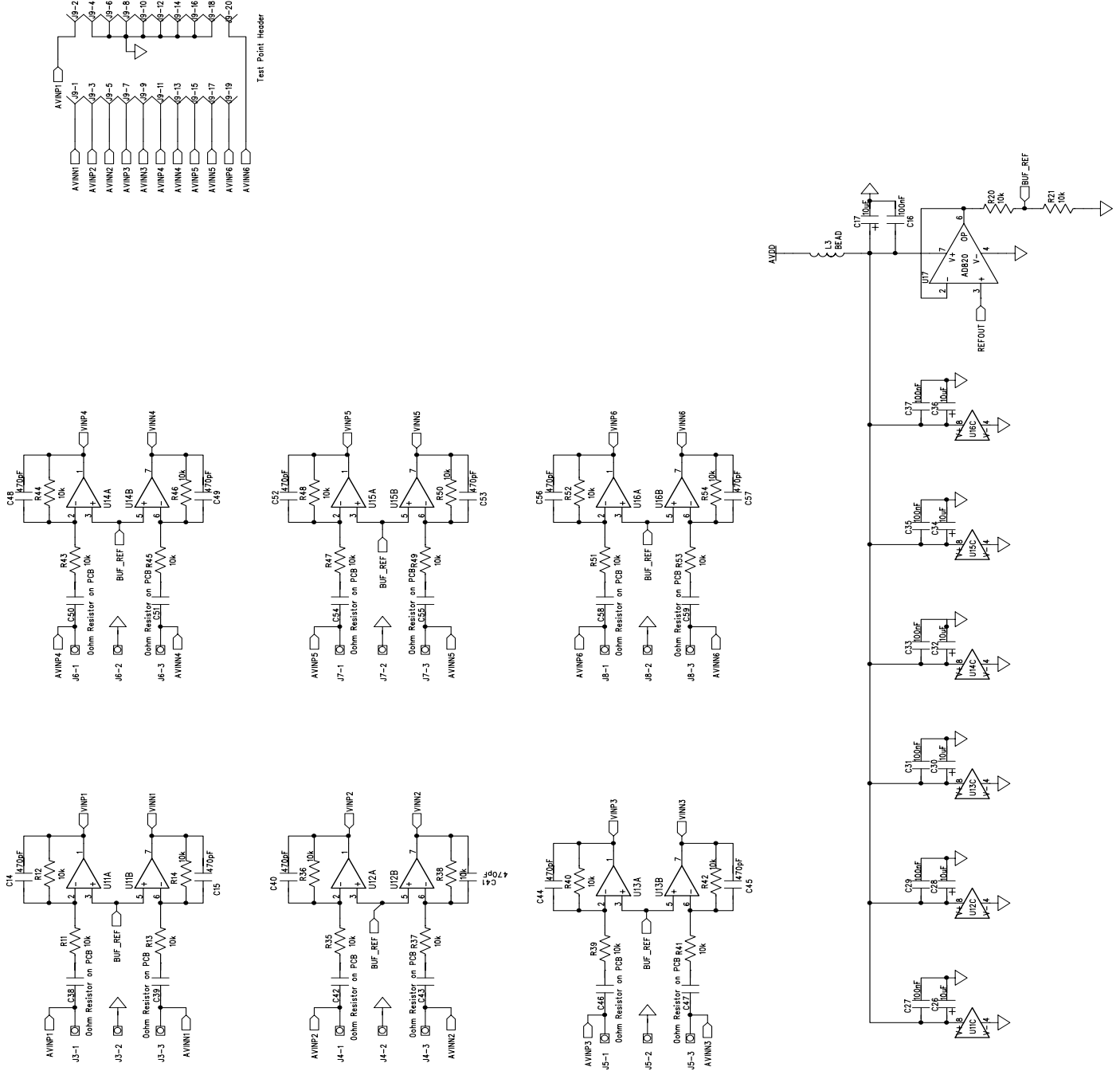

Figure 8. Evaluation Board Schematic (cont'd)

EVAL-AD73360(L)EB

Table VI. Troubleshooting guide

Symptom	Possible Cause
Both LEDs Off	No power is applied to the evaluation board. The evaluation board requires a +9V to +12V DC supply.
Power LED On but FL2 LED not flashing	The DSP has not booted properly. Remove the printer port cable, if connected, and press the RESET button.
No Communication between PC and Evaluation Board.	There are a number of possible causes for a communications failure. These are listed below. <ol style="list-style-type: none">1. Cable not connected or incorrect cable type. The cable should be a fully-populated Centronics printer port cable.2. Incorrect printer port. The evaluation board requires that the printer port has bi-directional capability. Acceptable types are PS/2, EPP and ECP.3. Correct Printer Port but bidirectional capability not enabled. It is possible that a bidirectional printer port can be set to be unidirectional mode in the PC BIOS. The user should consult the PC manual for instructions on examining the BIOS.4. Incorrect Printer Port Address. There are three possible addresses for a printer ports and the one fitted to a users PC may not be the same as the default address. This can be changed using the Printer Port menu item.
Demonstration Programs Timeout	The AD73360(L) may not be acquiring samples. Verify that the correct link positions are selected. Also verify that the SE and RESET are being brought high and that the the AD73360(L) is giving out the correct number of Frame Syncs per sample period once it is in program mode. Verify that the AD73360(L) is receiving an MCLK signal.

Table VII. Bill of Materials

Qty	Reference	Description/Part Name
1	U1	ADSP2185LLKST-133
1	U2	AD73360LAR or AD73360AR
1	U3	LM7805CT
1	U4	AM29LV004BB-90EC
1	U5	74VHC57M
2	U6	74LCX574WM
1	U7	74LVX02M
1	U8	74LVX32M
1	U9	74LVX74M
4	U10 U20-22	NC7S14M5
6	U11-16	AD8062AR
1	U17	AD820AR
1	U18	16.384MHz Programmable Oscillator
1	U19	ADP3303AR-3.2
1	U23	AD589LH
17	R1-R3 R7-R10 R15-R17 R23-R29	100KΩ
28	R4 R6 R11-R14 R20 R21 R35-R54	10KΩ
2	R5 R22	820Ω
1	R18	330KΩ
2	R19 R30	220KΩ
1	R31	5.6KΩ
3	L1-3	SMD Inductor
13	C5 C6 C10-C12 C20 C23 C26 C28 C30 C32 C34 C36	10uF
2	C19 C20	0.47μF
2	C1 C2	22pF
25	C3 C4 C7-C9 C13 C16 C18 C22 C24-25 C27 C29 C31 C33 C35 C37 C60-C65 C67	0.1μF
12	C14 C15 C40 C41 C44 C45 C48 C49 C52 C53 C56 C57	470pF
2	C21 C66 220nF	
12	C38 C39 C42 C43 C46 C47 C50 C51 C54 C55 C58 C59	0Ω Res to be fitted
1	J1	Centronics Connector
1	J2	20 Way IDC Header
6	J3-8	Pin Power Connector
1	J9	26 PIN EDGE CONNECTOR
1	J10	BARREL CONNECTOR
3	LK1 LK5 LK7	JUMPER BLOCK USING 3 PIN SIP HEADER
4	LK2-4 LK6	JUMPER BLOCK, 2 PINS 0.1 SPACING"
7	LK1-7	Shorting Plug
	D1	3mm Red LED
2	D4	3mm Green LED
2	D2-3	1N4001 Diode
1	Q1	2N2222 SMD Transistor
2	S1-2	Push Button Switch (sealed 6mm x 6mm)
1	Y1	20MHz Crystal